

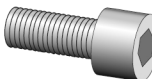

ULTIMATE SIX 6,5L (PLUS, HIGH VISIBILITY)



- DE MONTAGEANLEITUNG
- GB ASSEMBLY INSTRUCTIONS
- FR INSTRUCTIONS DE MONTAGE
- IT ISTRUZIONI DI MONTAGGIO
- NL MONTAGE HANDLEIDING
- DK MONTERINGSVEJLEDNING
- ES INSTRUCCIONES DE MONTAJE
- SE MONTERINGS ANVISNING
- NO MONTERINGS ANVISNING
- FI ASENNUSOHJEET
- PL INSTRUKCJA MONTAZU
- JP 装着方法



- A**  4 x M5x12
- B**  4 x

MOUNTING-SET REQUIRED

HANDLEBAR MOUNTING-SET QR

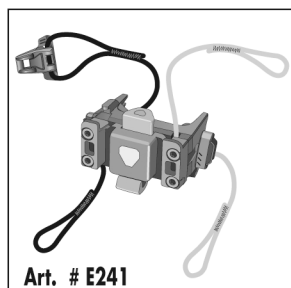

HANDLEBAR MOUNTING-SET

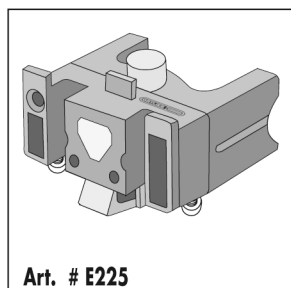

HANDLEBAR MOUNTING-SET WITH LOCK

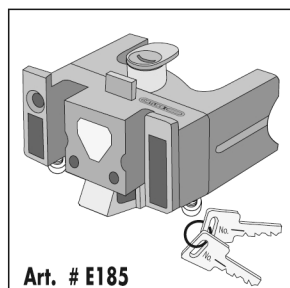

HANDLEBAR MOUNTING-SET E-BIKE

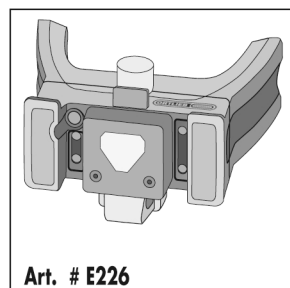

HANDLEBAR MOUNTING-SET E-BIKE WITH LOCK

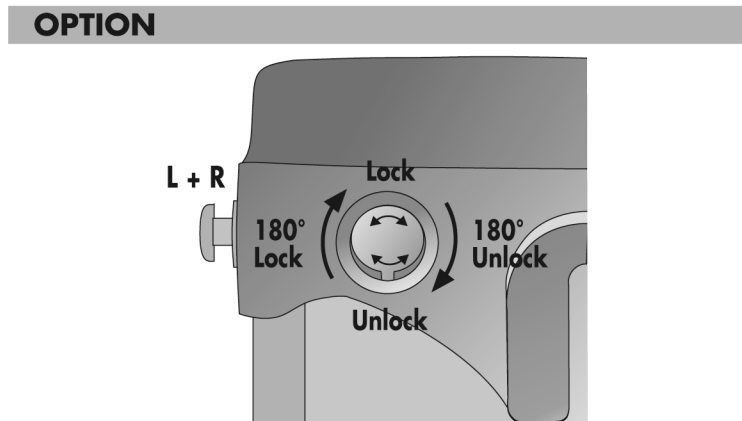
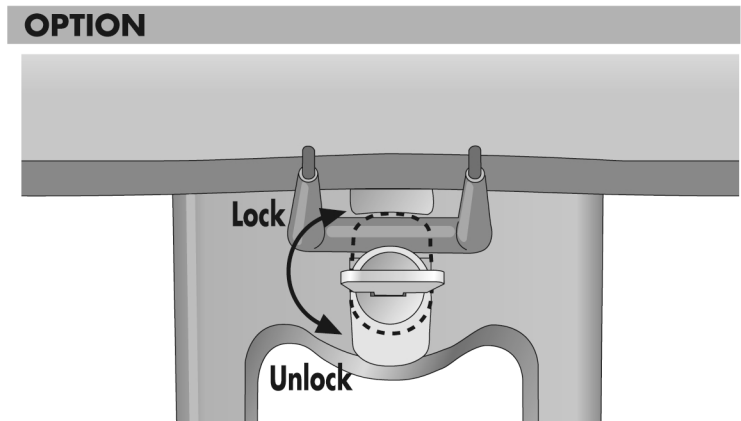
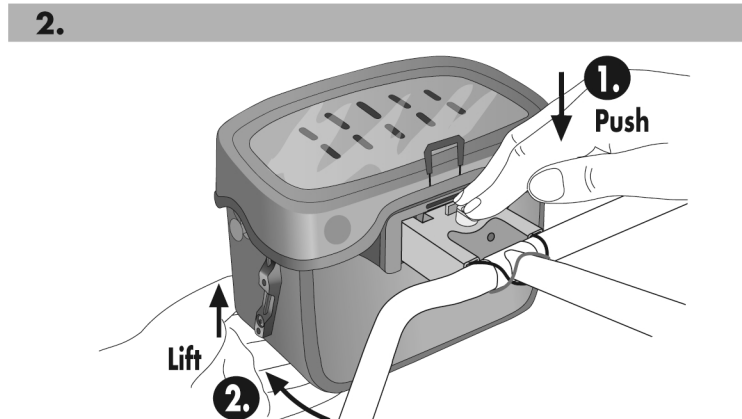
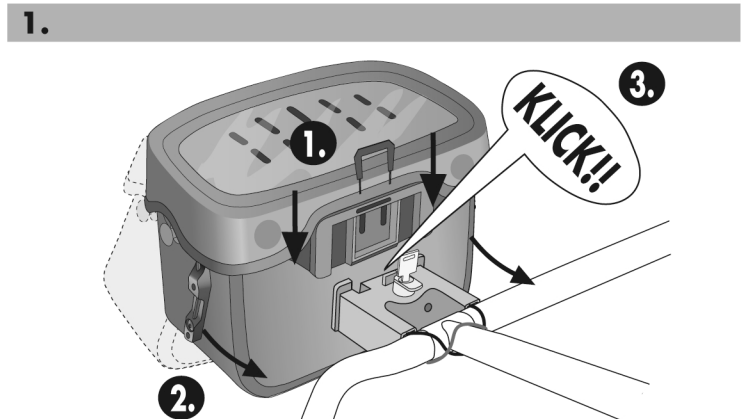
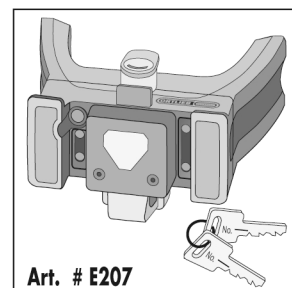

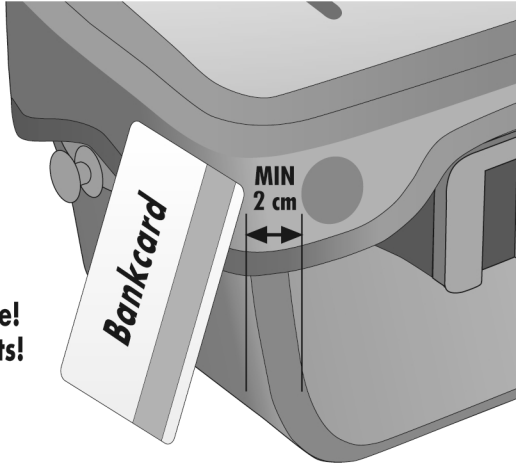

Achtung Magnete!
Attention magnets!

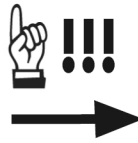

✓ = O.K.

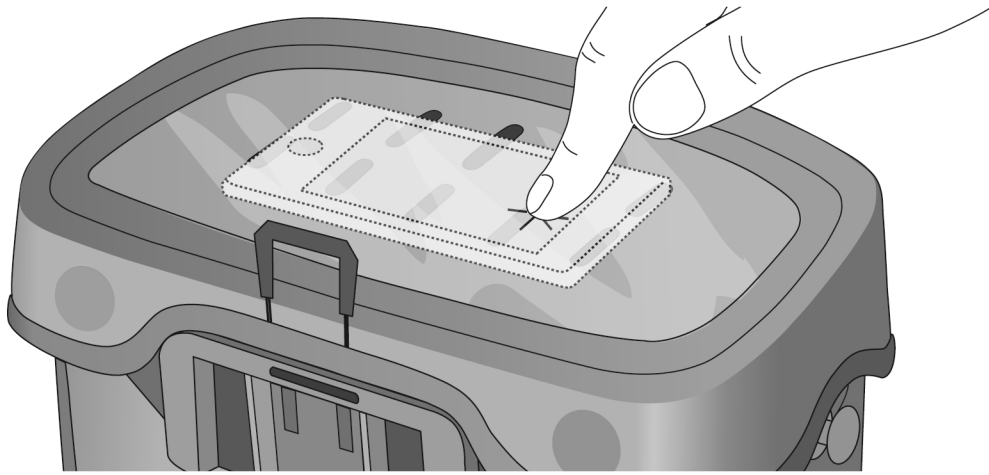

OPTION 2.1

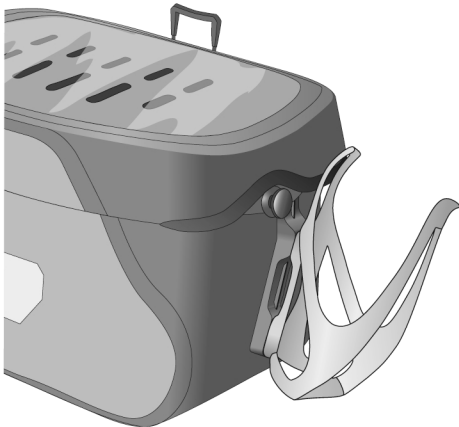

OPTION 2.2

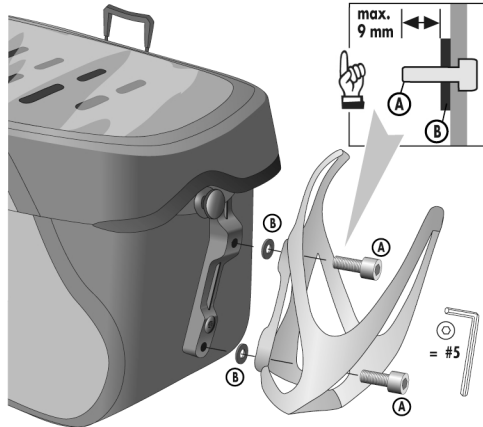

OPTION 2.3

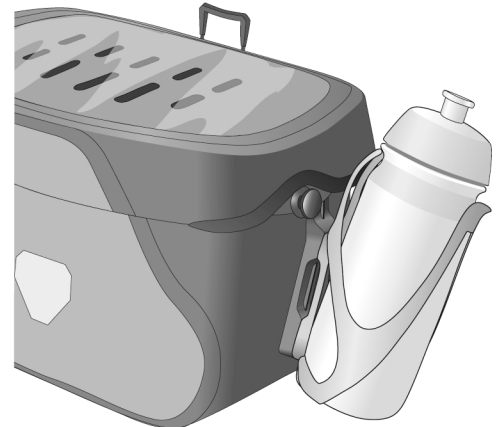

max. 5 kg incl.

